

5.3L Crate Engine Control System

Thank you for choosing GM Performance Parts as your high performance source. GM Performance Parts is committed to providing proven, innovative performance technology that is truly... more than just power. GM Performance Parts are engineered, developed and tested to exceed your expectations for fit and function. Please refer to our catalog for the GM Performance Parts Authorized Center nearest you or visit our website at www.gmperformanceparts.com.

This control system is a stand alone, fully-integrated kit designed to run 5.3L GM Performance Parts crate engines with 58x crankshaft reluctor wheels, 4x camshaft indexing, and electronic throttle control (ETC). Included in the kit are the engine control module (flashed with the appropriate calibration), engine harness, accelerator pedal, mass air flow (MAF) sensor, MAF sensor mounting boss, oxygen sensors (2), and oxygen sensor mounting bosses (2). This control system requires a fuel system which maintains 400 kPa (60 psi) constant pressure and can deliver 40 gph for the 5.3L. Vehicle performance/driveability and engine durability may be affected if the correct pressure or flow are not maintained. Included with this kit is a Serpentine Belt Accessory Drive Package that can be used with or without air conditioning.

IMPORTANT: Read the "System DOs and DON'Ts" section below before attempting to install the engine and then review again before attempting start the vehicle. Note that if the engine will not come off idle after the control system installation, check for an illuminated MIL (malfunction indicator light, which is located in the fuse/relay center, sometimes called the "Check Engine Light" or "Service Engine Soon" light) which indicates stored fault codes. Check for codes and make any required repairs if the MIL is illuminated (typically it is a connector issue or a wiring issue), consult a service manual if necessary (2007- 2011 Chevrolet Silverado Truck for the 5.3L engine).

Observe all safety precautions and warnings in the service manuals when installing this package in any vehicle. Wear eye protection and appropriate protective clothing. Support the vehicle securely with jack stands when working under or around it. Use only the proper tools. Exercise extreme caution when working with flammable, corrosive, and hazardous liquids and materials. Some procedures require special equipment and skills. If you do not have the appropriate training, expertise, and tools to perform any part of this conversion safely, this work should be done by a professional.

System DOs and DON'Ts:

Do:

- Ensure all intended engine/vehicle side connections are made before connecting ignition or battery power to the system.
- Ensure the wiring harness is secured as required, and that the routing avoids locations which can potentially damage the wiring (e.g.: sharp edges, pinch points, rotating components, exhaust components, etc.). Make sure any unused connectors or wiring are properly secured and protected (sealed or taped as required to avoid short circuiting).
- Ensure all engine and wiring harness grounds are clean and secure. Minimum 3/4 inch braided strap from the engine to the vehicle chassis is recommended.
- Ensure the MAF sensor is oriented correctly in the induction (it will only read correctly in the proper direction). An arrow is located on the sensor indicating correct flow direction. Verify this before welding the mounting boss, as the sensor will mount only one way in the boss.
- Ensure the MAF Sensor is mounted in the middle of a minimum 6 inch length of 4 inch diameter tube, and is a minimum of 10 inches from the throttle body.

- Ensure the fuel pressure is a constant 400 kPa (60 psi) with the engine running. This is what the control system has been developed to run.
- Ensure the fuel pump has the following flow capability: Minimum 40 gph @ 400 kPa for LC9 5.3L.
- Ensure battery voltage is connected using a minimum 8 gauge wire to one of the studs on the fuse block.
- Ensure that the accelerator pedal clearances meet the guidelines below.
- Ensure that the provided oil pressure sensor is installed and torque to 35 nm (26 lb-ft).

Don't:

- Change or alter any wiring in the accelerator pedal or electronic throttle systems.
- Vacuum reference the fuel system, it must run constant 400 kPa (60 psi).
- Solder or alter any Oxygen Sensor wiring.

Vehicle Requirements

Vehicle Speed Input - optional

The ECM is programmed and looking for 40 pulses per revolution typical for automatic transmissions. The 5.3L harness is designed to plug into the output speed sensor of 4L60 & 4L80 Transmissions, which have a 40 pulse output. **NOTE: If you are using the GMPP Supermatic Connect and Cruise Transmission Control System, the vehicle speed input must be plugged in.**

Axle Ratio and Tire Size Requirements

The axle drive ratio in the calibration is set to 3.42:1 and is okay for ratio from 3.08 to 4.11. Tire diameter needs to be between 26" and 30". **NOTE: For optimal performance choose an axle ratio and a tire size within the recommended range.**

NOTE:

All Engines are shipped with an automatic transmission flex plate. For manual applications, the clutch and flywheel used must be purchased separately and is up to the end user. See www.gmperformanceparts.com for recommended GMPP clutches and flywheels.

TITLE 5.3L Crate Engine Control System	IR26OC10	PART NO. 19258097	SHEET 1 OF 30
---	-----------------	--------------------------	-----------------------------

ALL INFORMATION WITHIN ABOVE BORDER TO BE PRINTED EXACTLY AS SHOWN ON 8 1/2 x 11 WHITE 16 POUND BOND PAPER. PRINT ON BOTH SIDES, EXCLUDING TEMPLATES. TO BE UNITIZED IN ACCORDANCE WITH GM SPECIFICATIONS.	DATE	REVISION	AUTH
	26OC10	Initial Release - William Duncan	

Also see the GMPP Catalog or GMPerformanceparts.com for recommended starter, flywheel and clutch components.

Parts List:

These instructions cover the following packages:

- 19256513 LC9 5.3L (40T – Pulse VSS Transmissions calibration)
- 12618419 5.3L RPO LC9 engine

Each Package includes an Emissions Engine Control Kit:

- 19256514 LC9 (40T – 40 tooth trans speed signal) with 19256515 Engine Control Module

All Emission Engine control kits have the following parts:

- 19258097 I-Sheet
- 19202596 Engine Harness
- 15865791 Mass Airflow Sensor
- 19166574 Mass Airflow Sensor Bracket
- 10379038 Accelerator Pedal
- 12581966 Oxygen Sensor - Quantity 2
- 15156588 Oxygen Sensor mounting boss – Quantity 2
- 19202598 MAP Sensor Jumper Harness
- 19256607 Cam Sensor Jumper Harness
- 12616646 Oil Pressure Sensor

Included Front End Accessory Drive (FEAD)

- 12626222 Belt
- 12580771 Pulley - Idler w/ bolt
- 20989651 Generator
- 11516360 Bolt - Generator
- 20756714 Pump - Power Steering
- 12554032 Brace - Power Steering
- 11514597 Nut - Power Steering – qty 2
- 11515764 Bolt - PS Brace
- 11515767 Bolt - PS & Compressor – qty 6
- 25891791 Compressor
- 12554026 Compressor Bracket
- 11516109 Bolt - Compressor long
- 11516503 Bolt - Compressor short
- 19210691 Belt kit (w/tool)

Power Steering Pulley Installation Tool:

- 9440957 Nut
- 19258317 Washer
- 19257882 Bolt - 3/8 x 16

Installation Instructions:

ECM

The Engine Control Module (ECM) is environmentally sealed and can be mounted underhood, however, avoid extremely hot locations (exhaust, etc.) or high splash areas. It is not recommended that the EMC be mounted directly to the engine.

ACCELERATOR PEDAL ASSEMBLY MINIMUM SPACING GUIDELINES

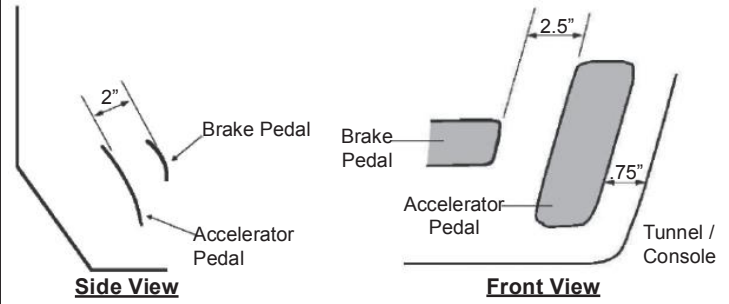

Accelerator Pedal

Mount the accelerator pedal per the following dimensional guidelines, mounting details are application-specific and are left to the user. Ensure that the pedal is securely mounted to the vehicle. A grommet is required in any sheet metal hole that the harness routes through to avoid wire damage.

Mass Air Flow (MAF) Sensor

NOTE: It is critical that the MAF sensor is mounted per the instructions below. Vehicle performance and/or driveability may be affected if it is not mounted as recommended.

The mass air flow sensor must be installed in the induction system using the supplied MAF sensor mounting boss. The induction system should be 4 inches in diameter and have a minimum straight section 6 inches in length. Mount the MAF sensor in the middle of the straight induction section, ensuring that the middle of the mounting boss is at least 10 inches from the throttle body.

The MAF sensor must be oriented correctly in the induction system – note the arrow on the sensor indicating flow direction. Be sure to weld the mounting boss correctly – the sensor will only mount one way in the boss (see diagram).

Weld the boss in place before installing the sensor. When installed in the vehicle, the MAF sensor should be mounted with the connector end pointing between horizontal and fully upright – do not mount with the connector oriented downward.

MAF SENSOR MOUNTING GUIDELINES

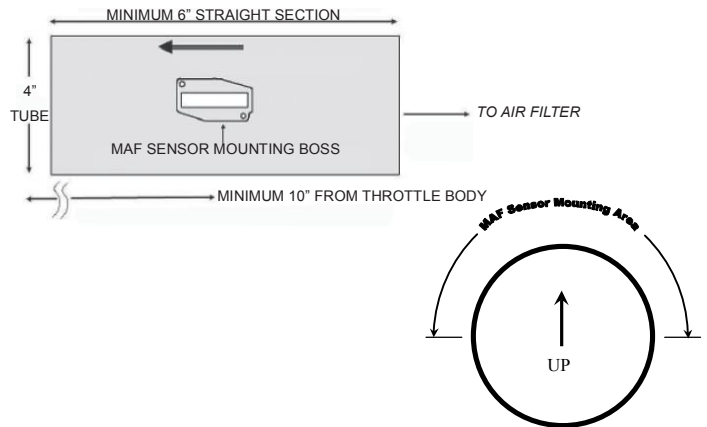

Air Cleaner:

It is recommended that a dry element air cleaner be used.

NOTE: Fueling cannot be guaranteed if an oiled element type air cleaner is used.

Oxygen Sensors

NOTE: It is critical that the Oxygen Sensors are mounted per the instructions below. The exhaust system **MUST** be properly sealed – any leak near the sensors (upstream or downstream) can cause incorrect operation of the fuel control system. Vehicle performance and/or driveability may be affected if sensors are not mounted as recommended or if an exhaust leak exists. Leak check the exhaust system to ensure adequate sealing (even small leaks can affect fuel control).

Oxygen Sensors should be mounted in the collector area of the exhaust manifolds in a location that allows exhaust from all cylinders to be sampled equally (stock exhaust manifolds include a mounting boss for the oxygen sensors). Be sure the connectors and wiring are routed away from high heat areas. The oxygen sensors should be mounted with the sensor tip pointing between horizontal and fully downward – do not mount with the tip oriented upward. Weld in the mounting bosses supplied (7/8" hole) if using headers.

Exhaust Manifolds:

It is recommended that you use the provided exhaust manifolds or similar LS Engine style Exhaust Manifolds.

Positive Crankcase Ventilation System (PCV)

How to set up your PVC system:

There are two ports on the engine that make up the PCV system. The ports on the engine are **1)** Left rear (driver side) valve cover. **2)** Top center of the inlet manifold. The ports with silver tubes may look simple but, they should not be modified. The tubes have a small orifice within them that is used in place of a PCV valve of earlier designs.

There is one fresh air port which is on the front of the right (passenger side) valve cover. Again this is a silver tube that faces forward on the valve cover. This port should be connected to filtered clean air. This connection must be within the engines air cleaner system and must be between the MAF (Mass Air Flow Sensor) and engine's throttle body. The engine burns the air that enters the PCV system so, if the fresh air port is prior to the MAF then, this air will enter the engine without being measured by the MAF and adverse engine operation may occur.

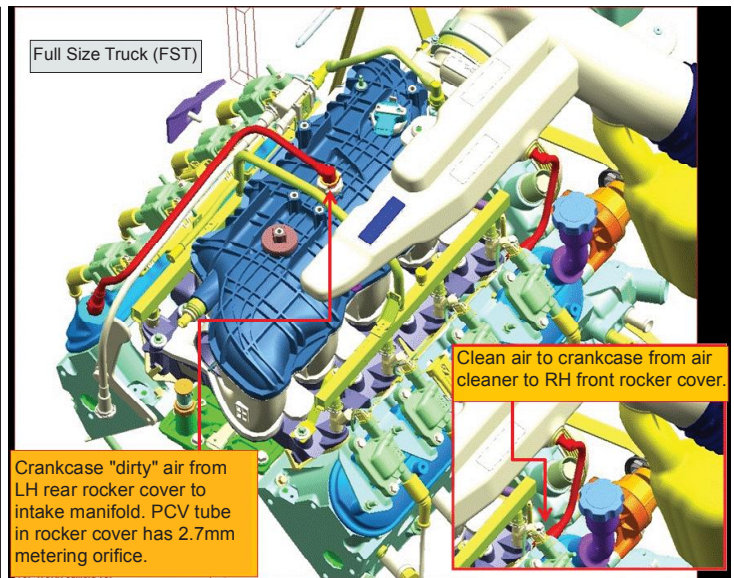

Power Brake Booster Vacuum Source:

The vacuum port for the Brake Booster is a plug in the rear of the intake manifold. If you need the vacuum source for your brake system the plug needs to be removed and you will need fitting #12559760 available from any GM dealer.

Oil Pressure Sensor:

You must change the oil pressure sensor that comes on the engine and install the sensor provided in the kit. Tighten the sensor to 35 N·m (26 lb ft).

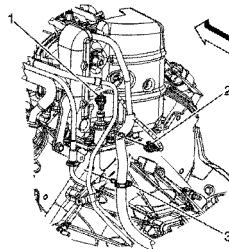

Engine Wiring Harness

The following lists the engine and vehicle side connections. Optional circuits are described in the 'System Features' section below:
NOTE: A Malfunction Indicator Lamp (MIL- sometimes called a "service engine soon" light) is mounted inside the fuse/relay center. A redundant MIL output is also available in the harness near the pedal module connector. It is recommended that a MIL also be installed in a visible location in the passenger compartment. This circuit requires any 12v low current light and an ignition 12v power source. The ECM MIL output supplies the ground for the circuit.

Connections Required for Correct Operation

- Coolant Sensor – 2 pin Connector
- Mass Air Flow (MAF) Sensor – 5 pin Connector
- Camshaft Position Sensor – 3 pin Connector
- Electronic Throttle Control – 6 pin Connector
- Manifold Absolute Pressure (MAP) Sensor – 3 pin Connector
- Oxygen Sensors (2 total) – 5 pin Connectors
- Knock Sensors (2 total) – 2 pin Connectors

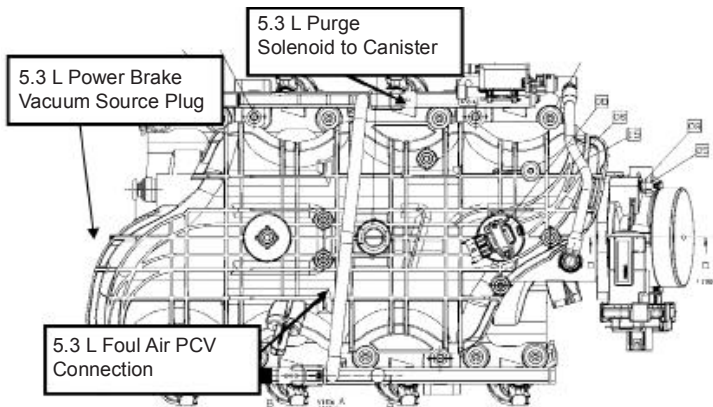

DATE	REVISION	AUTH

- Ignition Coil Blocks (2 total) – 8 pin Connectors
- Fuel Injectors (8 total) – 2 pin Connectors
- Crankshaft Position Sensor – 3 pin Connector
- Accelerator Pedal Sensor – 6 pin Connector
- Vehicle Speed Sensor – 2 pin Connector
- Ignition Switch Input (Wire) Wire
- Fuel Pump Control (Wire) Wire
- Engine Grounds (3 total) Eyelets
- Battery Power (Stud at Fuse/Relay Center)
- 5.3L LC9 requires the provided Map Sensor Jumper Harness (19202598)
- Cooling Fan Control Wire
- Engine Oil Pressure Sensor – 3 pin Connector

Optional Connections (Not required for operation)

- Alternator Control Connector
- Optional User Outputs Bulkhead – 12 pin Connector (12-way)

Connections

Connect all engine/vehicle-side connectors before connecting the harness to the ECM. All engine/vehicle-side connectors are functionally labeled, consult a service manual if necessary to determine connection locations (see following service manual information).

NOTE: It may be easier to install the harness on the engine before installing the engine into the vehicle.

The harness includes a fuse/relay center containing all required fuses and relays, and also a 12-way bulkhead connector (with sealed mating connector) which contains outputs that may be useful to the user (see 'Bulkhead Connector Outputs' section below). The fuse/relay center should be mounted as high in the engine compartment as possible to avoid unnecessary splash and road debris. Likewise, keep the 12-way bulkhead connector and diagnostic link connector (both connect from the fuse/relay center) as high and protected as possible.

The 3 ECM connectors are indexed to connect only in the correct locations. Install by pressing down firmly until the connector is seated, then pull the top slider bar down until it snaps and locks into place. The bar should slide easily and will not move unless the connector is seated properly, do not use excessive force.

Attach the harness ground eyelets (3 total) to the engine block, ensuring the connections are clean and secure, and attach the fuel pump wire from the fuse/relay center to the power side of the pump (this feed is fused and relay-controlled from the ECM).

Make sure all intended engine and vehicle side connections have been made before proceeding to connect power.

Attach a 12 volt ignition switch feed from the vehicle to the pink ignition switch wire in the harness (this is required to enable the proper power-up sequence of the ECM). This can be routed into the passenger compartment with the accelerator pedal connector and diagnostic link connector. Next, connect battery power (minimum 8 gauge wire) to one of the studs on the fuse relay center (3 studs are available, only 1 is required to be connected), and the harness installation is complete.

Additional features and bulkhead connector descriptions are also included below:

System Features

- The Fuse/Relay center contains all required fuses and relays for proper engine operation. Spare fuse and relay openings are provided for possible future customer use.

- The Fuse/Relay center includes a malfunction indicator light (MIL) which will illuminate in the event of an engine fault code. See your GM Performance Parts dealer to have this code retrieved at the diagnostic link connector in the fuse/relay center (using a Tech2 with GM Performance Parts Diagnostics selection or 2009 CTS LSA Manual Trans Configuration). Codes can also be retrieved using an aftermarket diagnostic scan tool capable of reading this configuration. **NOTE: The MIL will illuminate when the vehicle is keyed-up — this is normal, and it will go out once the engine is started if there are no current fault codes. A redundant MIL wire is included in the wiring harness to allow a light to mounted inside the passenger compartment. The wire is located in the wire bundle near the pedal connector and the ignition voltage.**
- A cooling fan is controlled by the ECM. Control is set to turn on a 12 V fan at 97 Deg C (207 Deg F) coolant temperature. The fan control wire is fused/relayed and must be connected directly to your fan.
- The fuel pump is controlled by the ECM. The control wire supplies 12 V and is fused/relayed and should connect to the 12 V side of the fuel pump.
- A tachometer signal is included in the bulkhead connector (see below). This is a 2 pulse/rev output which may correspond to a 4-cylinder setup in some tachometers or transmission controllers. Note the signal is a low voltage square wave, some tachometers or transmission controllers may need a pull-up resistor in order to read the signal, similar to a 5000 ohm, ¼ watt resistor— this detail is left to the user. The following circuit has worked for numerous devices – the resistor value may need to be changed if your device does not read this output properly.

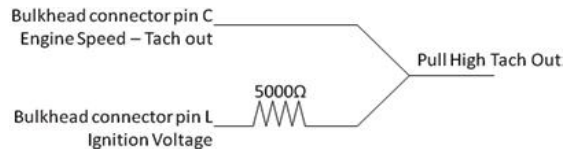

NOTE: When connected to the GMPP Supermatic Connect and Cruise Harness the pull up resistor is not required for the Transmission Controller.

- An oil pressure output is included in the bulkhead connector and can be used for a pressure gauge if desired (see below for scaling). The oil pressure sensor is required for the system to operate properly. **NOTE: Ensure that oil pressure sensor p/n 12616646 is installed for proper connection to the harness.**
- A vehicle speed output is included in the bulkhead connector for use with auto-scaling speedometers. The vehicle speed sensor connector in the harness must be attached to a variable reluctance type speed sensor (typical of most late model GM automatic transmissions) for this to function.

Bulkhead Connector Outputs

Bulk Head Connector Pin L	Mating Connector
15326849 Connector	15326854 Connector
12191818 Female Terminal	15304701 Male Connector
15366021 Seal	15366021 Seal
15305171 Plug	15305171 Plug
15430903 TPA	15430903 TPA
15317832 CPA	

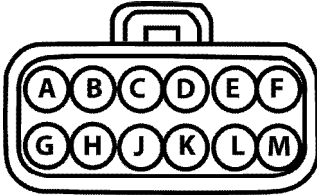

Load View or Rear View

Circuit #	Position	Wire Gage	Color	Description
2501A	A	22	Tan	GMLAN High Speed (-)
-	B	-	Plug	Empty
121	C	22	White	Engine Speed
818	D	22	Brown	Vehicle Speed - Out
432B	E	22	Lt. Green	MAP Signal
-	F	-	Plug	Empty
2500A	G	22	Tan/Black	GMLAN Low Speed (+)
331B	H	22	Tan/White	Oil Pressure Signal
486B	J	22	Purple	Throttle Pos #2 (0.5v - 4.5v)
40F	K	18	Orange	Battery Power Fuse
5292	L	18	Pink	Ignition "OnPower"
50B	M	18	Black	Ground

Bulkhead connector outputs - Terminals for the included mating connector can be acquired at a GM dealership in the Delphi Terminal Service kit. Terminals are Delphi part number 15326269 (GM part number 19167018), and wire seals are Delphi part number 15366021 (white seal). At many dealerships these can be found at the Service Desk.

- GMLAN Communication Link (TAN/BLACK STRIPE [+], TAN [-]) – This provides the GMLAN communication messages containing engine operating parameters for potential use in future add on modules – any current integration of this is left to the user. Can be used with a LAN dash or an electronic dash readout display.
- Tachometer Signal (WHITE) – This is a 2 pulse/rev output (see features above).
- Vehicle Speed (BROWN) – This is a non scaled output for use with auto-scaling speedometers and will not function unless a vehicle speed sensor (VSS) is connected to the ECM through the VSS wire in the harness.
- MAP (LT GREEN) – This is an output for use in gauges or for load indication in transmission controllers (any connection must be to high-impedance device). The output is a 0-5 Volt signal ranging from 10 – 105 KPa (1.5 – 15.2 psia). Use the ground wire in the bulkhead connector as the low reference (ground).

- Oil pressure Sensor (TAN/WHITE STRIPE) – This is the output from the oil pressure sensor which can be used for monitoring (Pressure (psig) = [32*Sensor Voltage]-16). Use the ground wire in the bulkhead connector as the low reference (ground).
- Throttle Position (PURPLE) - This is an output for use in gauges or for load indication in transmission controllers (any connection must be to a high-impedance device). The output is a 0.5 – 4.5 volt signal ranging from 0 – 100 %. Use the ground wire in the bulkhead connector as the low reference (ground).
- 10A Fused 12V Power (ORANGE) - This is a power output supply and is always enabled.
- 15A Fused 12V Ignition Power (PINK) – This is a power output supply and is enabled only when the ignition is on.
- Ground (BLACK) – This is used as the low reference (ground) for completion of the MAP, TPS, and oil pressure output circuits. It can also be used for modules connected to either of the fused 12V outputs.

Terminals for the included mating connector can be acquired at a GM dealership in the Delphi Terminal Service kit (J38-125) in tray 8 position 9. At most dealerships this can be found at the Service Desk.

NOTE: If you are using GMPP Supermatic Transmission Controller Kit, #19212657, the Tachometer Signal (WHITE) and Throttle Position (PURPLE) are required to be connected. If you are using GMPP Supermatic Connect and Cruise Kit, #19257634 or 19257661, the Bulk Head Connector must be plugged into the GMPP Supermatic Connect and Cruise harness. For the Connect and Cruise, the tachometer signal and the throttle position signal are received through the bulk head connector.

Start-up and Break-in Procedures

Safety first. If the vehicle is on the ground, be sure the emergency brake is set, the wheels are chocked and the car cannot fall into gear. Verify everything is installed properly and nothing was missed.

1. **Oil & Fluid Fill:** This engine assembly may need to be filled with oil or have oil added. After installing the engine, ensure the crankcase has been filled with the appropriate motor oil to the recommended oil fill level on the dipstick. The 5.3L Crate Engine requires a special oil meeting GM Standard GM4718M (this will be specified on the oil label). Mobil 1 is one such recommended oil. Other oils meeting this standard may be identified as synthetic. However, not all synthetic oils will meet this GM standard. Look for and use only oil that meets GM Standard GM4718M. Also check and fill as required any other necessary fluids such as coolant, power steering fluid, etc.
2. **Oil System Prime:** a. The engine should be primed with oil before starting. Install an oil pressure gauge (the existing oil pressure sensor location at the upper rear of the engine may be used) and disconnect the engine control system (removing power from the engine control module is generally recommended). **NOTE: Disconnecting only ignition or fuel injector connectors is not recommended – make sure the control system will not provide ignition or fuel to the engine.** b. Once the engine control system has been disconnected, crank the engine using the starter for 10 seconds and check for oil pressure. If no pressure is indicated, wait 30 seconds and crank again for 10 seconds. Repeat this process until oil pressure is indicated on the gauge.
3. **Initial Engine Start:** Reconnect the engine control system. Start the engine and listen for any unusual noises. If no unusual noises are noted, run the engine at approximately 1000 RPM until normal operating temperature is reached.

DATE	REVISION	AUTH

4. **Engine Warm Up Recommendation:** When possible, you should always allow the engine to warm up prior to driving. It is a good practice to allow the oil sump and water temperature to reach 180°F before towing heavy loads or performing hard acceleration runs.
5. **First 30 Mile Break-In Period:** The engine should be driven at varying loads and conditions for the first 30 miles or one hour without wide open throttle (WOT) or sustained high RPM accelerations.
6. **Medium Accelerations for Break-In:** Run five or six medium throttle (50%) accelerations to about 4000 RPM and back to idle (0% throttle) in gear.
7. **Hard Accelerations for Break-In:** Run two or three hard throttle (WOT 100%) accelerations to about 4000 RPM and back to idle (0% throttle) in gear.
8. **Change the oil and filter:** Replace the oil per the specification in step 1, and replace the filter with a new PF48 AC Delco oil filter. Inspect the oil and the oil filter for any foreign particles to ensure that the engine is functioning properly.
9. **500 Mile Break-In Period:** Drive the next 500 miles (12 to 15 engine hours) under normal conditions. Do not run the engine at its maximum rated engine speed. Also, do not expose the engine to extended periods of high load.
10. **Change the oil and filter after 500 Mile Break-In:** Again, inspect the oil and oil filter for any foreign particles to ensure that the engine is functioning properly.

Service information

Contact your GM Performance Parts Dealer for Service or for instructions on how to obtain Service Manuals and Service Information. Use information from GM Performance Parts Diagnostics which can be selected from the first menu on the Tech2 for engine and harness diagnosis (use this information for all LS Crate Engine Systems).

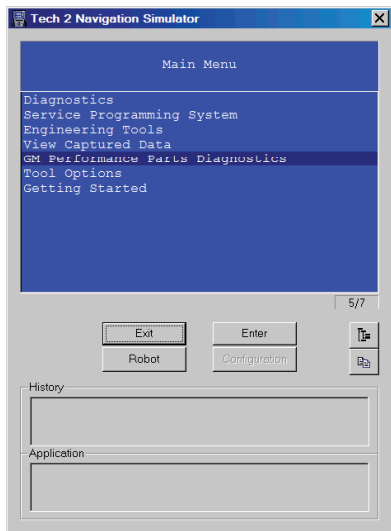

Appendix: See www.GMPerformanceParts.com for recommended starters, clutch and flywheels for the manual applications and accessory drive parts.

How the PVC System Works:

A closed crankcase ventilation system must be used in order to provide a more complete scavenging of crankcase vapors. Filtered air from the air induction system (air cleaner) duct is supplied to the crankcase, mixed with blow-by vapors, and passes through a crankcase ventilation metering device before entering the intake manifold. The primary component

in the positive crankcase ventilation (PCV) system is the PCV flow metering orifice. Vacuum changes within the intake manifold result in flow variations of the blow-by vapors. If abnormal operating conditions occur, the design of the PCV system permits excessive amounts of blow-by vapors to back flow through the crankcase vent tube and into the engine induction system (air cleaner) to be consumed during normal combustion. This engine ventilation system design minimizes oil consumption and significantly reduces the potential for oil ingestion during vehicle limit handling maneuvers.

ECM Connectors Pinouts:

ECM	
Blue	
Item C1	
34576-0703 Connector	
33467-0003 Term (22 GA)	
33467-0005 Term (18 GA)	
34586-0001 Plug	
34575-003 Dress Cover	

Circuit #	Pos	Wire Gage	Color	
239M	10	22	Pink	Power
419	12	22	Brown/White	CEL Light
465	13	22	Green/White	Fuse Bus Pos 7A
239	19	18	Pink	Power
1440	20	22	Red/White	Fuse Bus Pos 6G
121	25	22	White	Engine Speed Bulk Head Pos C
1164	33	22	White/Black	Pedal Module Pos F
1374	35	22	Red	Pedal Module Pos C
1271	36	22	Brown	Pedal Module Pos D
1272	37	22	Purple	Pedal Module Pos A
818	39	22	Brown	Pin D Bulk Head
5069	40	22	Brown	Fuse Bus Pin 1A
PDL 1	47	22	Blue	Pedal Module Pos E
PDL 2	49	22	Lt. Blue	Pedal Module Pos B
473	54	22	Blue	Fuse Bus 7D

All Other Positions to have Cavity Plugs

ECM	
Black	
Item C2	
34566-0103 Connector	
33467-0003 Terminal (22 GA)	
33467-0005 Terminal (18 GA)	
7158-3113-40 Seal (1 each)	
7116-4152-02 Term (1 each)	
34586-0001 Plug (40 each)	
34565-0003 Dress Cover	

Circuit #	Pos	Wire Gage	Color	
2121	1	22	Purple	Odd Coil Pin G

DATE	REVISION	AUTH

Circuit #	Pos	Wire Gage	Color	
1664	2	22	Tan	Odd Fr O2 Sensor Pos A
1665	3	22	Purple/white	Odd Fr O2 Sensor Pos B
1876	6	22	Lt. Blue	Even Knock Pos A
407	7	22	Tan	Even Knock Pos B
496	8	22	Blue	Odd Knock Pos A
1716	9	22	Gray	Odd Knock Pos B
581	11	22	Yellow	ETC Pos B
582	12	22	Brown	ETC Pos A
5290	13	18	Pink/Black	Pos 1B Bulk Head
5284	14	22	Purple	Cam Phaser Control Pos D
1746	16	22	Lt. Blue/Black	Injector 3 Pos B
2128	17	22	Purple/white	Even Coils Pos G
2124	18	22	Green/White	Even Coils Pos C
2130	19	22	Brown/White	Even Coils Pos E
632	23	22	Pink/Black	Cam Sensor Ground Pos B
2755	24	22	Black	Oil Pressure Sensor Rtn Pos A
1868	27	22	Yellow/Black	Crank Sensor Ground Pos B
1704	28	22	Pink/Black	Fuse Cavity 8J
1704A	29	22	Red/White	ETC Pos C
1745	32	22	Lt. Green/Black	Injector 2 Pin B
2127	33	22	Orange	Odd Coil Pos B
2127A	34	22	Green	Odd Coil Pos C
2129	35	22	Brown	Odd Coil Pos E
631	39	22	Orange	Cam Sensor Power Pos A
2705	40	22	Gray	Oil Pressure Sensor 5V Ref Pos B
552	42	22	Tan	MAF Pos D
1867	43	22	Lt. green	Crank Sensor Signal Pos C
1688	44	22	Lt. Blue/Black	ETC Pos E
6753	46	22	Brown	Cam Phaser Low Pin E
878	48	22	Blue/White	Injector 8 Pin B
847	49	22	Tan/White	Injector 5 Pin B
846	52	22	Yellow/Black	Injector 6 Pin B
2122	53	22	Red/White	Even Coils Pos B
2126	54	22	Lt. Blue/White	Even Coils Pos F
2123	55	22	Lt. Blue	Odd Coils Pin F

Circuit #	Pos	Wire Gage	Color	
633	59	22	Brown/White	Cam Sensor Signal Pos C
331A	60	22	Tan/White	Oil Pressure Sensor Signal Pos C
472	62	22	Tan	MAF Pos E
1869	63	22	Blue/White	Crank Sensor Power Pos A
485	64	22	Green	ETC Throttle Pos. Sensor #1 Pos D
486	66	22	Purple	ETC Throttle Pos. Sensor #2 Pos F
492	67	22	Yellow	MAF Pos A
3113	68	22	Gray/White	Odd Fr O2 Heater pos E
3122	69	22	Gray/White	Odd Rear O2 heater
844	70	22	Lt. Blue/Black	Injector 4 Pin B
877	71	22	Orange/Black	Injector 7 Pin B
1744	72	22	Tan	Injector 1 Pin B
750	73	14	Black	Ground

All Other Positions to have Cavity Plugs

ECM
Gray
Item C3
3466-0203 Connector
33467-0003 Terminal (22 GA)
7158-3113-40 Seal (1 each)
7116-4152-02 Term (1 each)
34586-0001 Plug
34565-0003 Dress Cover

Circuit #	Pos	Wire Gage	Color	
1667	3	22	Tan	Even Fr O2 Pos A
1666	4	22	Purple	Even Fr O2 Pos B
1670	5	22	Purple	Even Rear O2 Sensor Hi
1671	6	22	Tan	Even Rear O2 Sensor Lo
225	7	22	Orange	Generator Pos B
3212	15	22	Lt. Green	Even Fr O2 Pos E
469	23	22	Orange/Black	MAP Pos A
2501	33	22	Tan	ALDL Pin 14
2761	35	22	Tan	ECT Pos 1
2704	39	22	Gray	MAP Pos C
335	49	22	Green	Fuse Bus Pos 7D
3223	50	22	Orange/White	Even rear O2 Heater Pin E
2500	53	22	Tan/Black	ALDL Pin 6

TITLE **5.3L Crate Engine Control System**

IR26OC10

PART NO. **19258097**

SHEET **7** OF **30**

ALL INFORMATION WITHIN ABOVE BORDER TO BE PRINTED EXACTLY AS SHOWN ON 8 1/2 x 11 WHITE 16 POUND BOND PAPER. PRINT ON BOTH SIDES, EXCLUDING TEMPLATES.

TO BE UNITIZED IN ACCORDANCE WITH GM SPECIFICATIONS.

DATE	REVISION	AUTH

Circuit #	Pos	Wire Gage	Color	
410	55	22	Yellow	Engine Coolant Sensor Pos 2
432	59	22	Lt. Green	MAP Pos B
821	66	22	Purple/ White	VSS TOSS Hi Pos 2
822	67	22	Lt. Green/ Black	VSS TOSS Lo Pos 1
750A	73	14	Black	Ground

All Other Positions to have Cavity Plugs

Serpentine Belt Accessory Drive Package Specifications

With or Without Air Conditioning

Below provides general information on the installation of a GM Performance Parts serpentine belt accessory drive package (serpentine belt package). This serpentine belt package includes all the necessary brackets and hardware, pulleys, tensioner, alternator, power steering pump, A/C compressor and belt.

This package is designed to provide you a complete serpentine belt accessory drive package. This kit is based on the accessory drive system from late model light duty truck. It uses factory engineered brackets and components to ensure high quality as well as the GM belt tensioner to maintain proper belt tension during operation.

Installation Procedure:

The figure below shows the accessory drive package installed on a typical 5.3L application. Refer to this picture and following pictures for clarification during the installation of the various components included in this package.



NOTE: If you are installing Air Conditioning, it is recommended to install the A/C compressor, bracket and belt before installing the main drive belt. If you are not using air conditioning, skip the first 3 steps and begin on step 4.

1. Install the A/C compressor bracket 12554026 using (3) bolts 11515767 and torque bolts to 50 Nm (37 lb ft).



2. Install A/C Compressor 25891791 using (3) 11516109 (long) and (1) 11516503 (short) bolt and torque to 50 Nm (37 lb ft).



3. Install A/C belt as per instructions included in the belt kit.

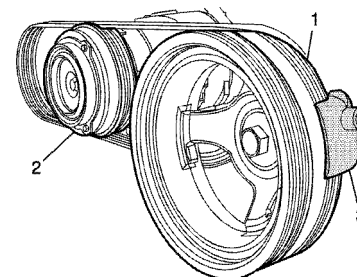

4. Install Power Steering Pump Brace 12554032 to rear of pump using (2) 11514597 nuts and torque to 50 Nm (37 lb ft).

DATE	REVISION	AUTH



5. Install Power Steering Pump to bracket using (3) 11515767 bolts and torque to 50 Nm (37 lb ft).



6. Install brace bolt 11515764 to block and torque to 50 Nm (37 lb ft).

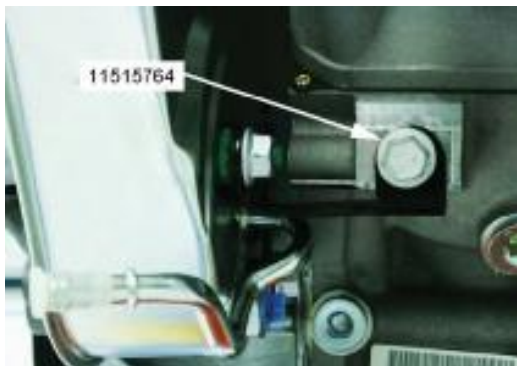

7. Install Power Steering Pump Pulley to Pump using the supplied 3/8 x 16 bolt, nut, and washer. Thread the bolt into the shaft all the way until it bottoms out (finger tight). Start the pulley by hand onto the end of the pump shaft and align it so it will press on straight. Using the washer and nut, snug the pulley onto the shaft and recheck to ensure the pulley is starting straight.



8. Using two wrenches hold the bolt and tighten the nut against the washer to press the pulley onto the shaft. The pulley is completely installed once the outside of the pulley hub is flush with the end of the pump shaft (see picture below)



9. Install Generator using (2) 11516360 bolts and torque to 55 Nm (41 lb ft).



10. Install Idler Pulley 12580771 on bracket boss below Generator as shown. Torque bolt to 50 Nm (37 lb ft).

DATE	REVISION	AUTH



11. Install belt as shown.

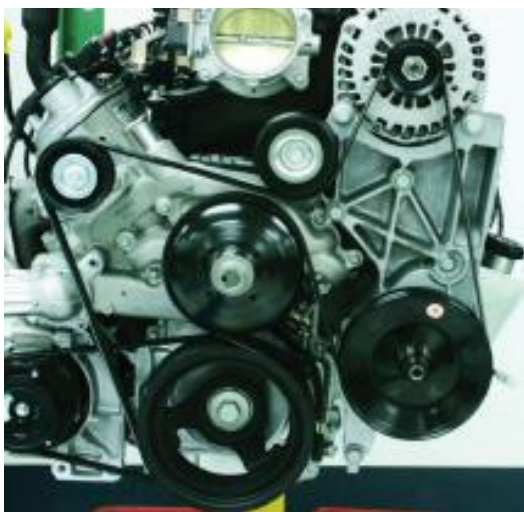

These specifications are intended as a supplement to GM service manuals. It is not the intent of these specifications to replace the comprehensive and detailed service practices explained in the GM service manuals.

The information contained in this publication is presented without any warranty. All the risk for its use is entirely assumed by the user. Specific component design, mechanical procedures, and the qualifications of individual readers are beyond the control of the publisher, and therefore the publisher disclaims all liability incurred in connection with the use of the information provided in this publication.

Chevrolet, Chevy, the Chevrolet Bow Tie Emblem, General Motors, and GM are all registered trademarks of the General Motors Corporation.

DATE	REVISION	AUTH